

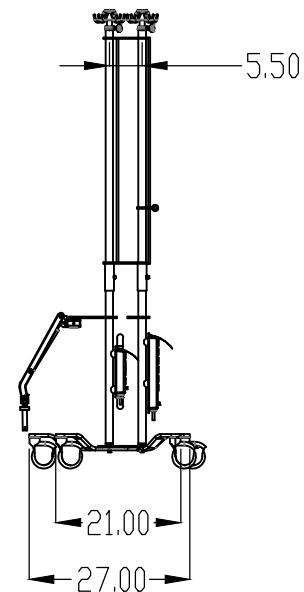

CAT. NO. 1100-QK

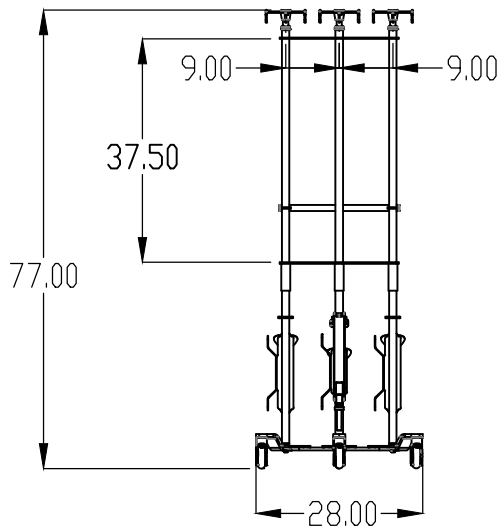
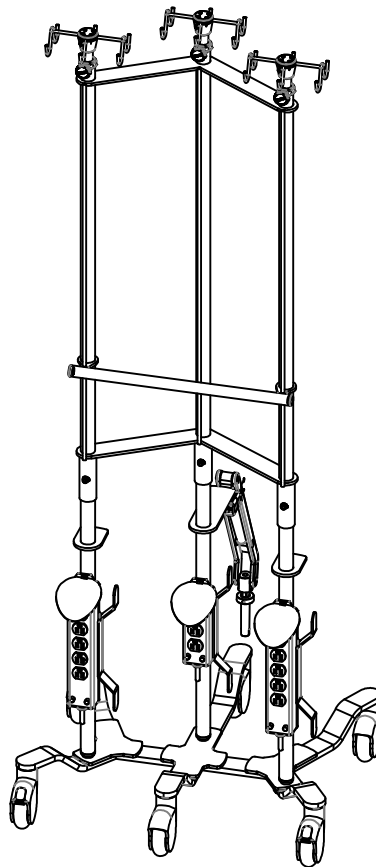

SIX-LEGGED HEAVY WEIGHT BASE 28.00" X 27.00". OFF WHITE EPOXY FINISH. WITH, 6 EA SOFT RUBBER 4" BALL BEARING CASTERS, 2 EA LOCKING. CORD WRAP WITH 2 EA. 6-OUTLET, 1 EA. 4-OUTLET UL APPROVED HOSPITAL-GRADE ELECTRICAL STRIP, WITH PROTECTIVE COVER. QWIK-IT BED TRANSPORT ARM. STAINLESS STEEL PUMP ADAPTER WITH STAINLESS STEEL PUMP DEFEAT HANDLES AND SLOW DESCENDING TELESCOPING POLES WITH 18 STAINLESS STEEL HOOKS. 100.00" FULLY EXTENDED 77.00" COMPRESSED. SHIPPING BOX IS TBD SHIPPING WEIGHT IS APPROXIMATELY 107 LBS.

NOTE: ALL DIMENSIONS ARE IN INCHES.