

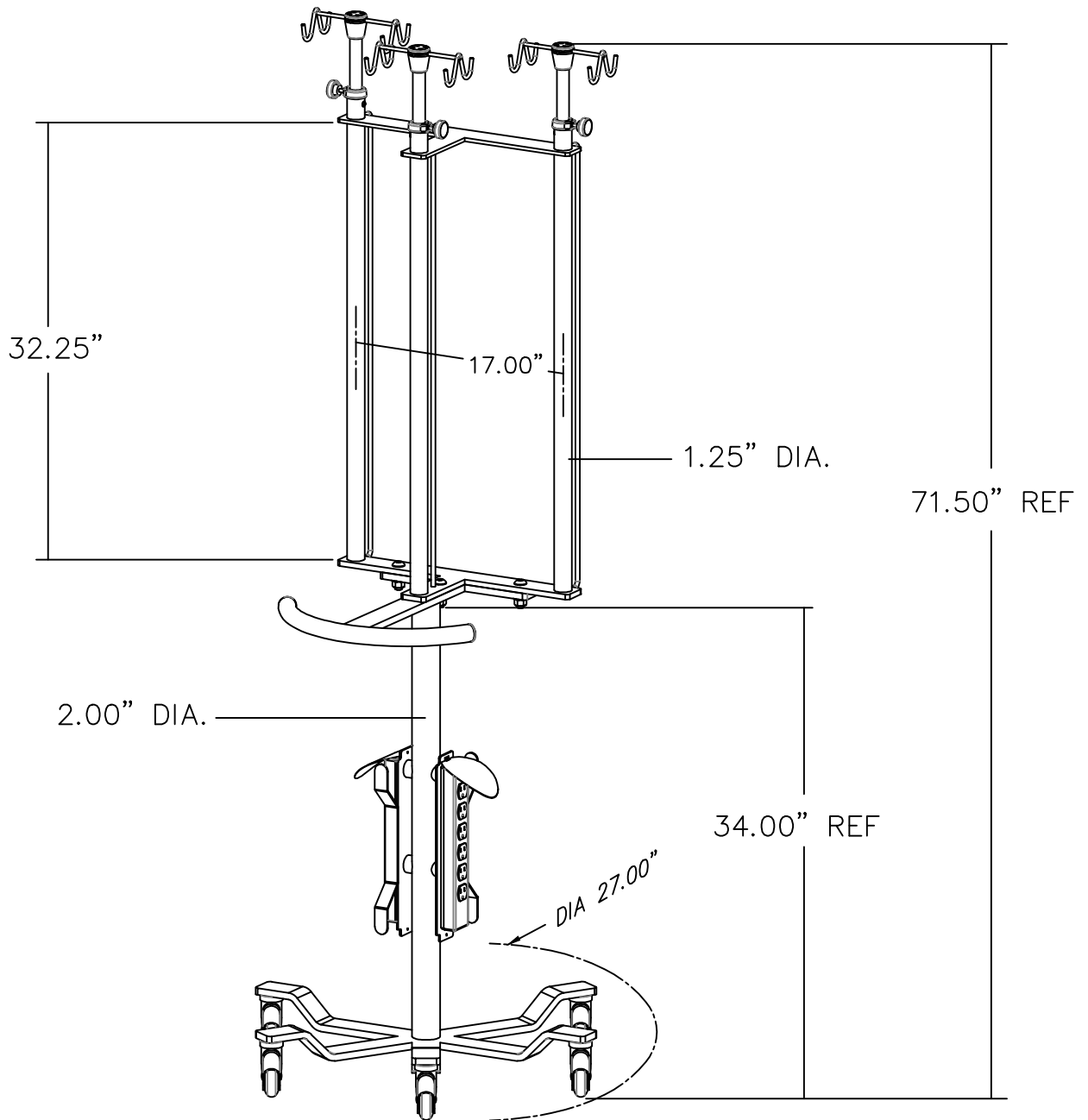

CAT. NO. 900



SIX-LEGGED HEAVY WEIGHT EXTRA THICK BASE 27.00" IN DIA. OFF WHITE EPOXY FINISH WITH, 6 EA SOFT RUBBER 3" BALL BEARING CASTERS, CORD WRAP WITH 2ea. 6 OUTLET UL APPROVED HOSPITAL-GRADE ELECTRICAL STRIP, WITH PROTECTIVE COVERS. CENTER-G DESIGNED 3 POLE STAINLESS STEEL PUMP ADAPTER WITH STAINLESS STEEL DEFEAT BARS, WITH AN OFF WHITE FINISH. SLOW DESCENDING TELESCOPING POLES WITH 12 STAINLESS STEEL HOOKS. 99.00" FULLY EXTENDED 71.50" COMPRESSED. SHIPPING BOX IS 13 X 13 X 35 HEX BOX. SHIPPING WEIGHT IS APPROXIMATELY 65 LBS.

NOTE: ALL DIMENSIONS ARE IN INCHES.